



KLE500

BMW

SBL.08.327.100
Revision: 01



KAWASAKI KLE 500

Schutzbügel Montagehinweise

Alle vom Motorrad gelösten Schrauben sind gemäß Herstellerangaben wieder zu montieren, oder mit von SW-MOTECH gelieferten Schrauben zu ersetzen. Falls nicht anderweitig definiert, diese Schrauben nach Tabelle anziehen.

M6	9,6 Nm
M8	23 Nm
M10	46 Nm

Gegebenenfalls Schrauben mit flüssiger Schraubensicherung einkleben.

Prüfen Sie nach 50 km alle Verbindungen auf festen Sitz.

SW-MOTECH GmbH & Co. KG
Bahnhofstrasse 44d
35282 Rauschenberg
-Germany-

Tel.: ++ 49 (0) 6425 8168 00
Fax: ++ 49 (0) 6425 8168 10

www.sw-motech.com

Crash Bar Mounting Instructions







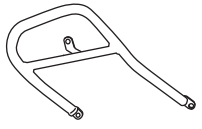
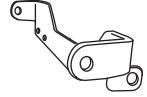

SW-MOTECH products should be installed by a qualified, experienced motorcycle technician. If you are unsure of your ability to properly install a product, please have the product installed by your local motorcycle dealer. SW-MOTECH takes no responsibility for damages caused by improper installation.

All screws, bolts and nuts, including all replacement hardware provided by SW-MOTECH, should be tightened to the torque specified in the OEM maintenance manual for your motorcycle. If no torque specifications are provided in the OEM maintenance manual, the following torques may be used:

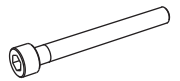
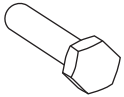
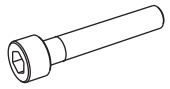
M6	9,6 Nm
M8	23 Nm
M10	46 Nm

All screws, bolts and nuts should be checked after driving the first 50 km to ensure that all are tightened to the proper torque.

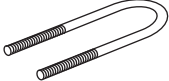
Medium strength liquid thread-locker (i.e., "Locktite") should be used to secure all screws, bolts and nuts.

<p>1 Schutzbügel Crash Bar</p>  <p>SBL.08.327.901/902 Anzahl/ Pcs. 2 (L/R)</p>	<p>5 Anbautraverse Bracket</p>  <p>SBL.08.327.001 Anzahl/ Pcs. 1</p>	<p>9 Mutter mit Bund Locking Nut</p>  <p>M 8 DIN 6927 Anzahl/ Pcs. 2</p>
<p>2 Zylinderschraube mit Innensechskant Hexagon Socket</p>  <p>M 10 x 300 DIN 912 Anzahl/ Pcs. 1</p>	<p>6 Sechskantschraube Hexagon Screw</p>  <p>M 10 x 1,25 x 35 DIN 961 Anzahl/ Pcs. 1</p>	<p>10 Zylinderschraube mit Innensechskant Hexagon Socket</p>  <p>M8 x 25 DIN 912 Anzahl/ Pcs. 2</p>
<p>3 Unterlegscheibe Washer</p>  <p>A 10,5 DIN 125 Anzahl/ Pcs. 1</p>	<p>7 Unterlegscheibe Washer</p>  <p>A 10,5 DIN 125 Anzahl/ Pcs. 1</p>	<p>11 Unterlegscheibe Washer</p>  <p>A 8,5 DIN 125 Anzahl/ Pcs. 2</p>
<p>4 Mutter mit Bund Locking Nut</p>  <p>M 10 DIN 6927 Anzahl/ Pcs. 1</p>	<p>8 Bügelschraube Bowscrew</p>  <p>BUS.00.08.043.068.01 Anzahl/ Pcs. 1</p>	<p>12 Mutter mit Bund Locking Nut</p>  <p>M 8 DIN 6927 Anzahl/ Pcs. 2</p>

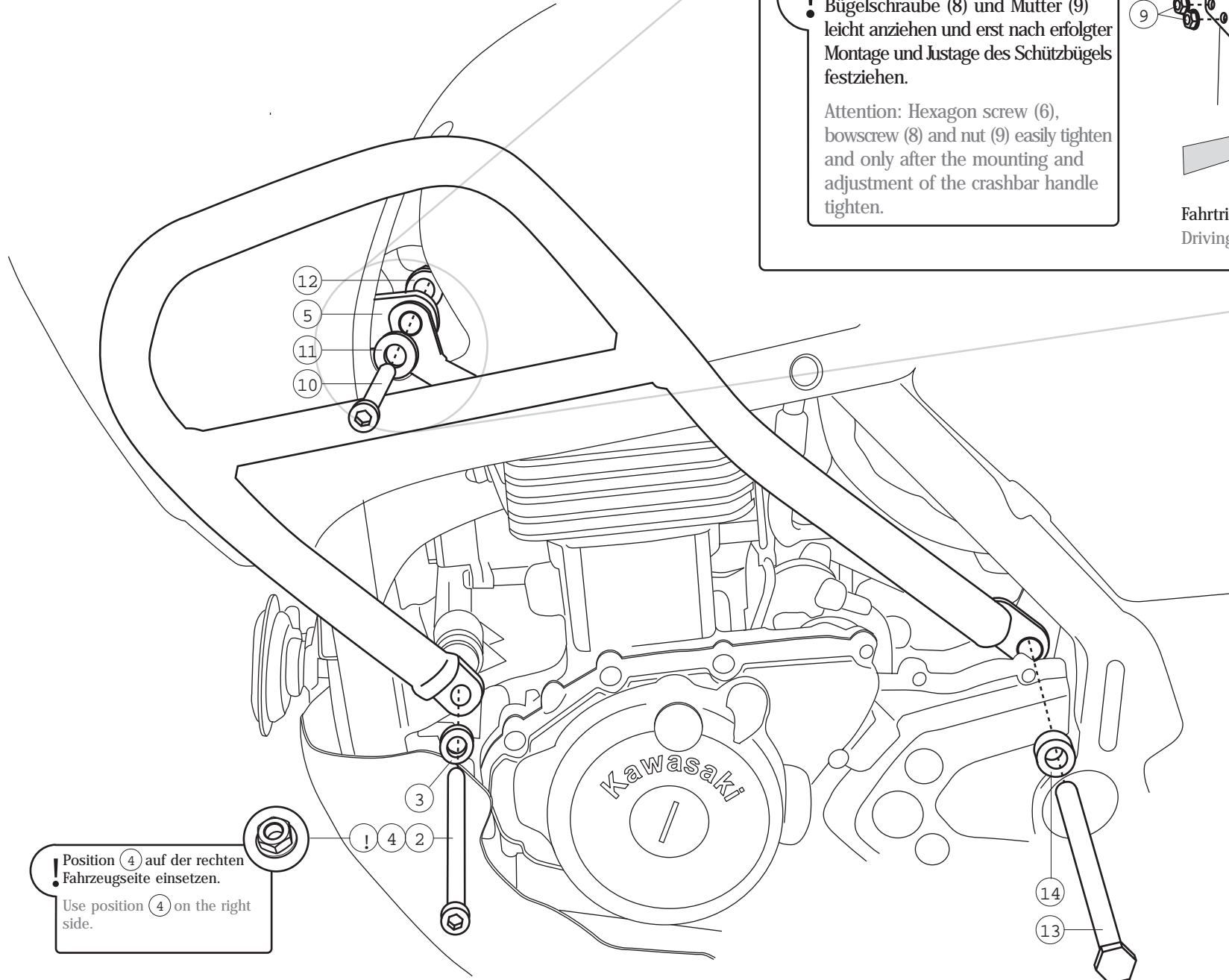

! Achtung: Sechskantschraube (6),
 Bügelschraube (8) und Mutter (9)
 leicht anziehen und erst nach erfolgter
 Montage und Justage des Schutzbügels
 festziehen.

Attention: Hexagon screw (6),
 bowscrew (8) and nut (9) easily tighten
 and only after the mounting and
 adjustment of the crashbar handle
 tighten.

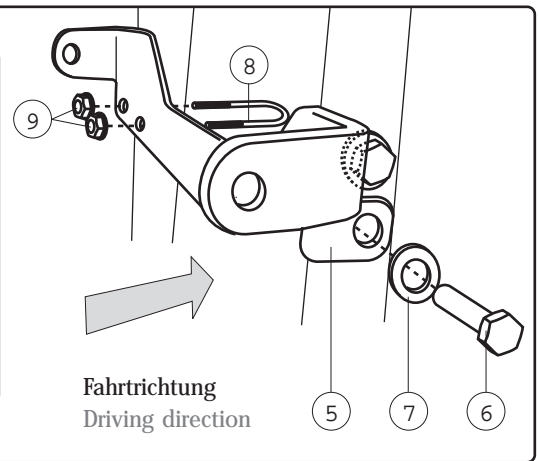

! Position (4) auf der rechten
 Fahrzeugseite einsetzen.
 Use position (4) on the right
 side.

13 Sechskantschraube
 Hexagon Screw

M10 x 180 DIN 931

Anzahl/ Pcs. 1

14 Distanzbuchse
 Spacer

Da:20 Di:10,5 h:6

Anzahl/ Pcs. 1

