



SBL.06.283.100



YAMAHA XT660

Schutzbügel Montagehinweise

Alle vom Motorrad gelösten Schrauben sind gemäß Herstellerangaben wieder zu montieren, oder mit von SW-MOTECH gelieferten Schrauben zu ersetzen. Falls nicht anderweitig definiert, diese Schrauben nach Tabelle anziehen.

M6	9,6 Nm
M8	23 Nm
M10	46 Nm

Gegebenenfalls Schrauben mit flüssiger Schraubensicherung einkleben.

Prüfen Sie nach 50 km alle Verbindungen auf festen Sitz.

Maximale Zuladung der Koffer :
Gemäß Herstellerangaben

SW-MOTECH GmbH & Co. KG
Bahnhofstrasse 44d
35282 Rauschenberg
-Germany-

Tel.: ++ 49 (0) 6425 816 800
Fax: ++ 49 (0) 6425 816 810

www.sw-motech.com

Crash Bar Mounting Instructions







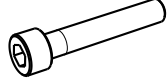
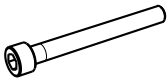
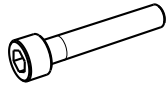

SW-MOTECH products should be installed by a qualified, experienced motorcycle technician. If you are unsure of your ability to properly install a product, please have the product installed by your local motorcycle dealer. SW-MOTECH takes no responsibility for damages caused by improper installation.

All screws, bolts, and nuts, including all replacement hardware provided by SW-MOTECH, should be tightened to the torque specified in the OEM maintenance manual for your motorcycle. If no torque specifications are provided in the OEM maintenance manual, the following torques may be used:

M6	9,6 Nm
M8	23 Nm
M10	46 Nm

All screws, bolts, and nuts should be checked after driving the first 50 km to ensure that all are tightened to the proper torque.

Medium strength liquid thread-locker (i.e., "Loctite") should be used to secure all screws, bolts, and nuts.

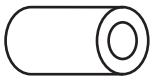
<p>1 Schutzbügel Crash Bar</p>  <p>SBL.06.283.901/902</p> <p>Anzahl/ Pcs. 2 (L/R)</p>	<p>5 Zylinderschraube mit Innensechskant Hexagon Socket Screw</p>  <p>M10 x 90 DIN 912</p> <p>Anzahl/ Pcs. 1</p>	<p>9 Zylinderschraube mit Innensechskant Hexagon Socket Screw</p>  <p>M10 x 240 DIN 912</p> <p>Anzahl/ Pcs. 1</p>
<p>2 Zylinderschraube mit Innensechskant Hexagon Socket Screw</p>  <p>M10 x 85 DIN 912</p> <p>Anzahl/ Pcs. 1</p>	<p>6 Unterlegscheibe Washer</p>  <p>A 10,5 DIN 125</p> <p>Anzahl/ Pcs. 1</p>	<p>10 Unterlegscheibe Washer</p>  <p>A 10,5 DIN 125</p> <p>Anzahl/ Pcs. 1</p>
<p>3 Unterlegscheibe Washer</p>  <p>A 10,5 DIN 125</p> <p>Anzahl/ Pcs. 1</p>	<p>7 Mutter mit Bund Locking Nut</p>  <p>M 10 DIN 6927</p> <p>Anzahl/ Pcs. 1</p>	<p>11 Mutter mit Bund Locking Nut</p>  <p>M 10 DIN 6927</p> <p>Anzahl/ Pcs. 1</p>
<p>4 Mutter mit Bund Locking Nut</p>  <p>M 10 DIN 6927</p> <p>Anzahl/ Pcs. 1</p>	<p>8 Distanzbuchse Spacer</p>  <p>Da=20 Di=10,5 h=3</p> <p>Anzahl/ Pcs. 2</p>	<p>12 Distanzbuchse Spacer</p>  <p>Da=20 Di=10,5 h=50</p> <p>Anzahl/ Pcs. 2</p>

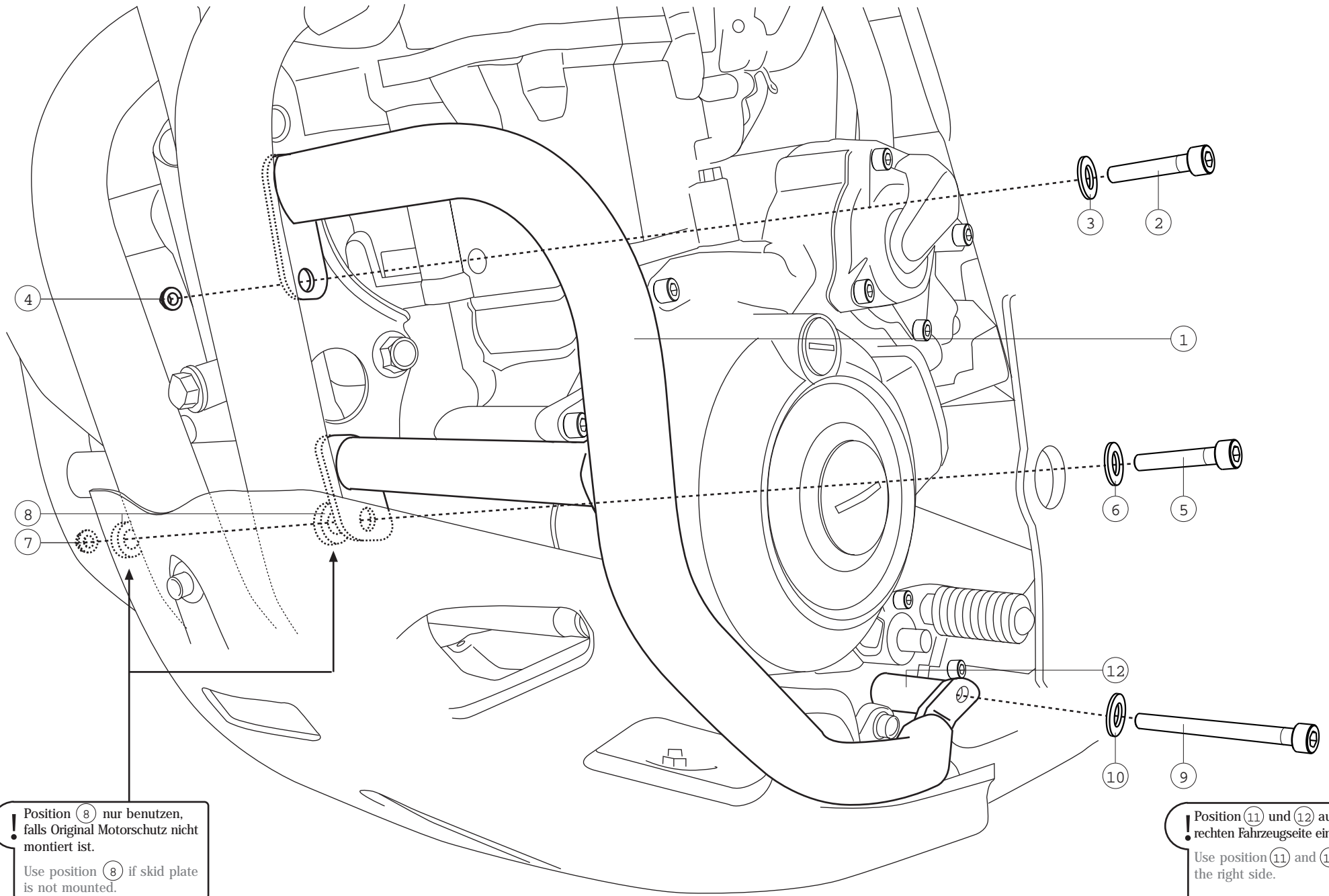

! Position ⑧ nur benutzen, falls Original Motorschutz nicht montiert ist.
Use position ⑧ if skid plate is not mounted.

! Position ⑪ und ⑫ auf der rechten Fahrzeugseite einsetzen.
Use position ⑪ and ⑫ on the right side.