

## Montagehinweise

Fahren Sie nicht ohne Koffer mit montierten Seitenplatten. Wenn sie ohne Gepäck fahren, Seitenplatten demontieren.

Alle vom Motorrad gelösten Schrauben sind gemäß Herstellerangaben wieder zu montieren, oder mit von SW-MOTECH gelieferten Schrauben zu ersetzen. Falls nicht anderweitig definiert, diese Schrauben nach Tabelle anziehen.

M6	9,6 Nm
M8	23 Nm
M10	46 Nm

Gegebenenfalls Schrauben mit flüssiger Schraubensicherung einkleben.

Prüfen Sie nach 50 km alle Verbindungen auf festen Sitz.

Maximale Zuladung der Koffer :  
Gemäß Herstellerangaben

## Mounting Instructions

German safety regulations require that no metal edge with a radius of less than 2.5mm be exposed while driving a motorcycle. Because Quick-Lock sidecase racks have edges with a radius of less than 2.5mm, Quick-Lock sidecase racks should not be used when luggage is not attached to them.

SW-MOTECH products should be installed by a qualified, experienced motorcycle technician. If you are unsure of your ability to properly install a product, please have the product installed by your local motorcycle dealer. SW Motech takes no responsibility for damages caused by improper installation.

All screws, bolts, and nuts, including all replacement hardware provided by SW-MOTECH, should be tightened to the torque specified in the OEM maintenance manual for your motorcycle. If no torque specifications are provided in the OEM maintenance manual, the following torques may be used:

M6	9,6 Nm
M8	23 Nm
M10	46 Nm

All screws, bolts, and nuts should be checked after driving the first 50 km to ensure that all are tightened to the proper torque.

Medium strength liquid thread-locker (i.e., "Loctite") should be used to secure all screws, bolts, and nuts.

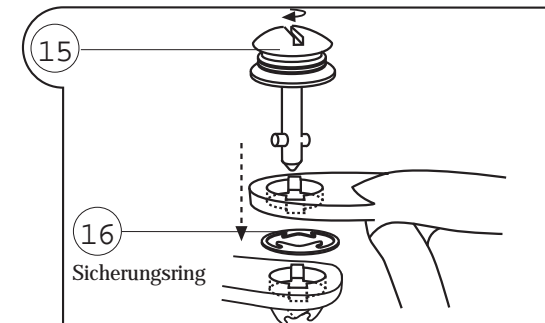

Zur Demontage des QUICK-LOCK-Kofferträgers einfach mit einer Münze oder einem Schraubendreher die Schnellverbinder lösen und Seitenträger entfernen.

SW-MOTECH GmbH & Co. KG  
Bahnhofstrasse 44d  
35282 Rauschenberg  
-Germany-

Tel.: ++ 49 (0) 6425 816 800  
Fax: ++ 49 (0) 6425 816 810

[www.sw-motech.com](http://www.sw-motech.com)

**1** Befestigungsblech  
Fixing Lug

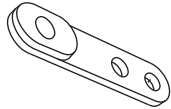

KFT.04.262.001L/R

Anzahl/ Pcs. 2

**4** Befestigungsblech  
Fixing Lug



KFT.00.077.004

Anzahl/ Pcs. 2

**7** Querverbinder  
Cross Girder



KFT.04.262.002

Anzahl/ Pcs. 1

**11** Querverbinder  
Cross Girder



KFT.00.064.003

Anzahl/ Pcs. 1

**15** Schnellverschluss mit  
Federscheibe  
Quick Fastener

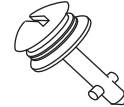

CAM.2312S21-12AHNV

Anzahl/ Pcs. 8

**2** Zylinderschraube  
mit Innensechskant  
Hexagon Socket Screw

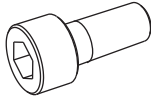

M8 x 20 DIN 912

Anzahl/ Pcs. 4

**5** Senkkopfschraube  
Countersunk screw

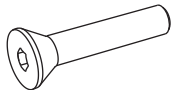

M8 x 70 DIN 7991

Anzahl/ Pcs. 2

**8** Senkkopfschraube  
Countersunk screw



M8 x 80 DIN 7991

Anzahl/ Pcs. 2

**12** Sechskantschraube  
Hexagon Screw

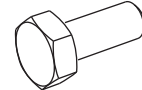

M6 x 20 DIN 933

Anzahl/ Pcs. 2

**16** Sicherungsring  
Retaining Ring



CAM.23.125.10-1BP

Anzahl/ Pcs. 8

**3** Unterlegscheibe  
Washer



A 8,4 DIN 125

Anzahl/ Pcs. 4

**6** Distanzbuchse  
Spacer



Da:13 Di:8,4 h:10

Anzahl/ Pcs. 2

**9** Senkkopfschraube  
Countersunk screw



M8 x 60 DIN 7991

Anzahl/ Pcs. 2

**13** Unterlegscheibe  
Washer



A 6,4 DIN 125

Anzahl/ Pcs. 2

**17** Distanzbuchse  
Spacer



Da:20 Di:8,5 h:9

Anzahl/ Pcs. 2

**10** Distanzbuchse  
Spacer



Da:20 Di:8,4 h:13

Anzahl/ Pcs. 2

**14** Mutter mit Bund  
Lock Nut



M6 DIN 6927/b

Anzahl/ Pcs. 2

**18** Formteil, schwarz  
Moulding, black



SE.00.8.4.02

Anzahl/ Pcs. 4

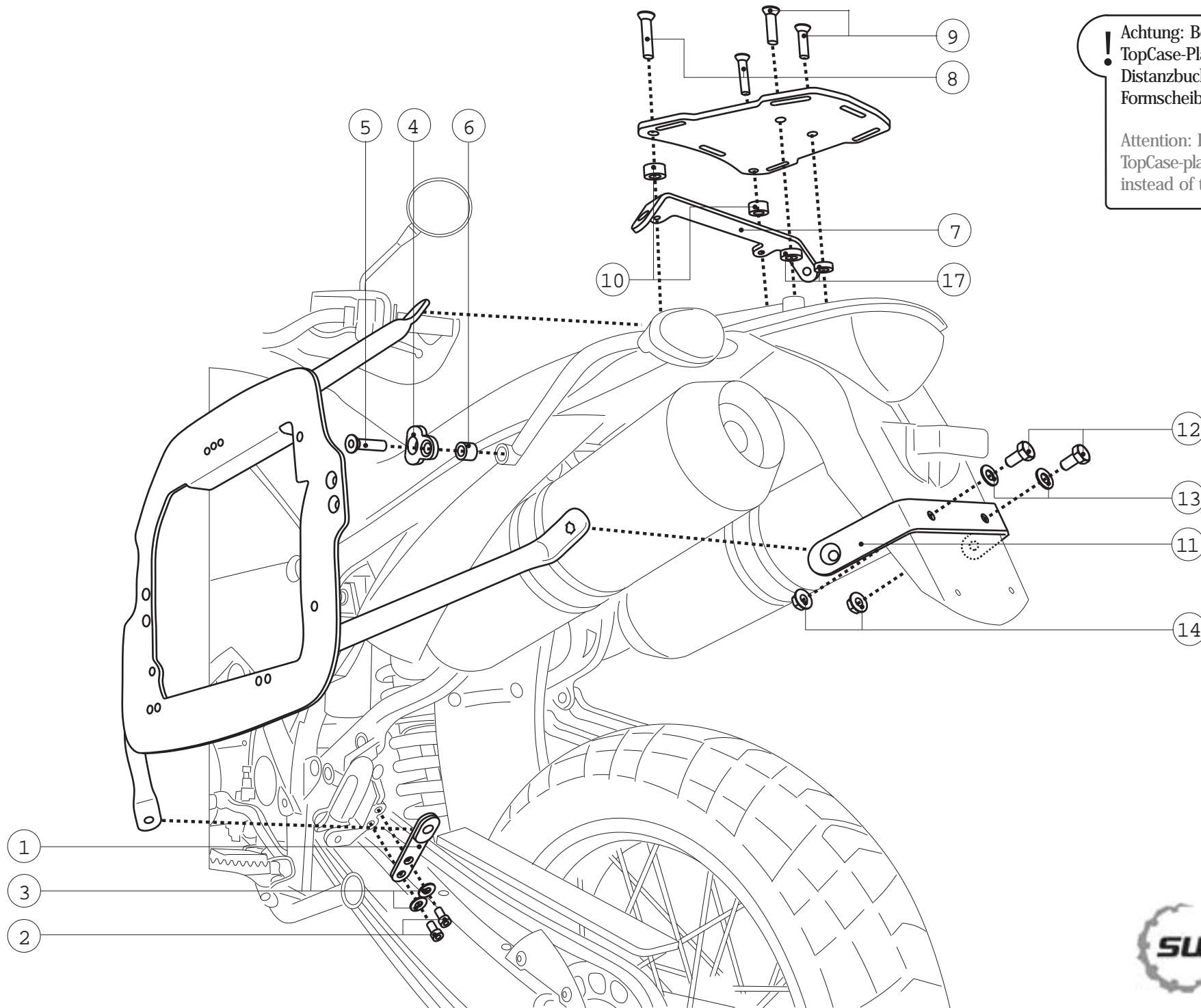

! Achtung: Bei Benutzung der Original TopCase-Platte müssen anstelle der Distanzbuchsen (10) und (17) die Formscheiben (18) benutzt werden.

Attention: If you mount the original TopCase-plate, use the mouldings (18) instead of the Spacers (10) and (17).